



FEATURES

- Output: 12 channels
- BUS+SEQUENCER+FADER+DIMMER+DRIVER
- Input: DC 12/24/48 Vdc (Supply voltage range 10,8Vdc – 53,5Vdc)
- BUS Command: DMX512-A+RDM, DALI, MODBUS
- Controls: Dimmer, Dim to Warm, Tunable White, RGB, RGBW
- Voltage output for R-L-C loads
- Typical efficiency > 95%
- Variation of the CCT warm white with decreasing light intensity (Dim to Warm)
- In RGB and RGBW mode it is possible to group the colors and manage them independently
- Adjusting the brightness up to completed off (Dim to Dark)
- Level minimum of brightness: 0,1% (1% in Push mode)
- D-PWM Modulation
- Adjusting D-PWM frequency: 300 / 600 / 1200 Hz
- Adjusting output curve: Linear / Quadratic / Exponential
- Soft start and soft stop
- Soft dimming regulation
- Extended temperature range
- 100% Functional test – 5 years warranty

→ For the whole and update Device Manual refer to producer's website: <http://www.dalcnet.com>

➤ CONSTANT VOLTAGE VARIANTS (common anode)

Application (12 – channel output): Dimmer, Dim to Warm, Tunable White, RGB, RGBW

CODE	Power Supply	Output	Channels	Command	
DLD1248-12CV-DMX	12/24/48V DC	1x20A max	12	DMX	PROFESSIONAL
		12x2A (max 20A tot)			
DLD1248-12CV-MODBUS	12/24/48V DC	1x20A max	12	MODBUS RTU	PROFESSIONAL
		12x2A (max 20A tot)			
DLD1248-12CV-DALI	12/24/48V DC	1x20A max	12	DALI	PROFESSIONAL
		12x2A (max 20A tot)			

➤ PROTECTIONS

OTP	Over temperature protection ¹
OVP	Over voltage protection
UVP	Under voltage protection
RVP	Reverse polarity protection ²
IFP	Input fuse protection ²
OCP	Open circuit protection
CLP	Current limit protection

¹ protection on the outputs

² protection on the control's logic

➤ REFERENCE STANDARDS

EN 61347-1	Lamp controlgear - Part 1: General and safety requirements
EN 61000-3-2	Electromagnetic compatibility (EMC) - Part 3-2: Limits - Limits for harmonic current emissions (equipment input current ≤ 16 A per phase)
EN 61000-3-3	Electromagnetic compatibility (EMC) - Part 3-3: Limits - Limitation of voltage changes, voltage fluctuations and flicker in public low-voltage supply systems, for equipment with rated current ≤ 16 A per phase and not subject to conditional connection
EN 62384	DC or AC supplied electronic control gear for LED modules - Performance requirements
EN 55015	Limits and methods of measurement of radio disturbance characteristics of electrical lighting and similar equipment
EN 61547	Equipment for general lighting purposes - EMC immunity requirements
EN 50581	Technical documentation for the assessment of electrical and electronic products with respect to the restriction of hazardous substances
IEC/EN 62386-101	Digital addressable lighting interface - Part 101: General requirements - System
IEC/EN 62386-102	Digital addressable lighting interface - Part 102: General requirements - Control gear
IEC/EN 62386-207	Digital addressable lighting interface - Part 207: Particular requirements for control gear – LED modules (device type 6)
ANSI E1.11	Entertainment Technology - USITT DMX512-A - Asynchronous Serial Digital Data Transmission Standard for Controlling Lighting Equipment and Accessories
ANSI E1.20	Entertainment Technology-RDM-Remote Device Management over USITT DMX512 Networks
-	MODBUS APPLICATION PROTOCOL SPECIFICATION V1.1b

➤ TECHNICAL SPECIFICATION

		Variant	
		Constant voltage	
Supply voltage		DC min: 10,8 Vdc .. max: 53,5 Vdc	
Output voltage		=Vin	
Input current		max 20A	
Output current		12x max 2 A (max 20A total)	1x max 20 A (12 parallel channels)
Nominal power ³	@12V	24 W/ch	240 Wtot
	@24V	48 W/ch	480 Wtot
	@48V	96 W/ch	960 Wtot
Power loss in standby mode		<500mW	
Type Load		R – L – C	
Thermal shutdown		150 °C	
D-PWM dimming frequency		300Hz / 600Hz / 1200Hz	
D-PWM resolution		16 bit	
D-PWM range		0,1% - 100%	
Storage Temperature		min: -40 max: +60 °C	
Ambient temperature ³		min: -40 max: +60 °C	
Wiring Button & Bus		1.5mm ² solid – 1 mm ² stranded - 30/14 AWG	
Wiring Power & Leds		2.5mm ² solid – 1.5 mm ² stranded - 30/12 AWG	
Protection grade		IP10	
Casing material		Plastic	
Packaging unit (pieces/unit)		Single Carton Box 1 pz	
Mechanical dimensions		143 x 91 x 62 mm – DIN RAIL 8M	
Packaging dimensions		156 x 124 x 71 mm	
Weight		205g	

³ maximum value, dependent on the ventilation conditions

➤ **INSTALLATION**

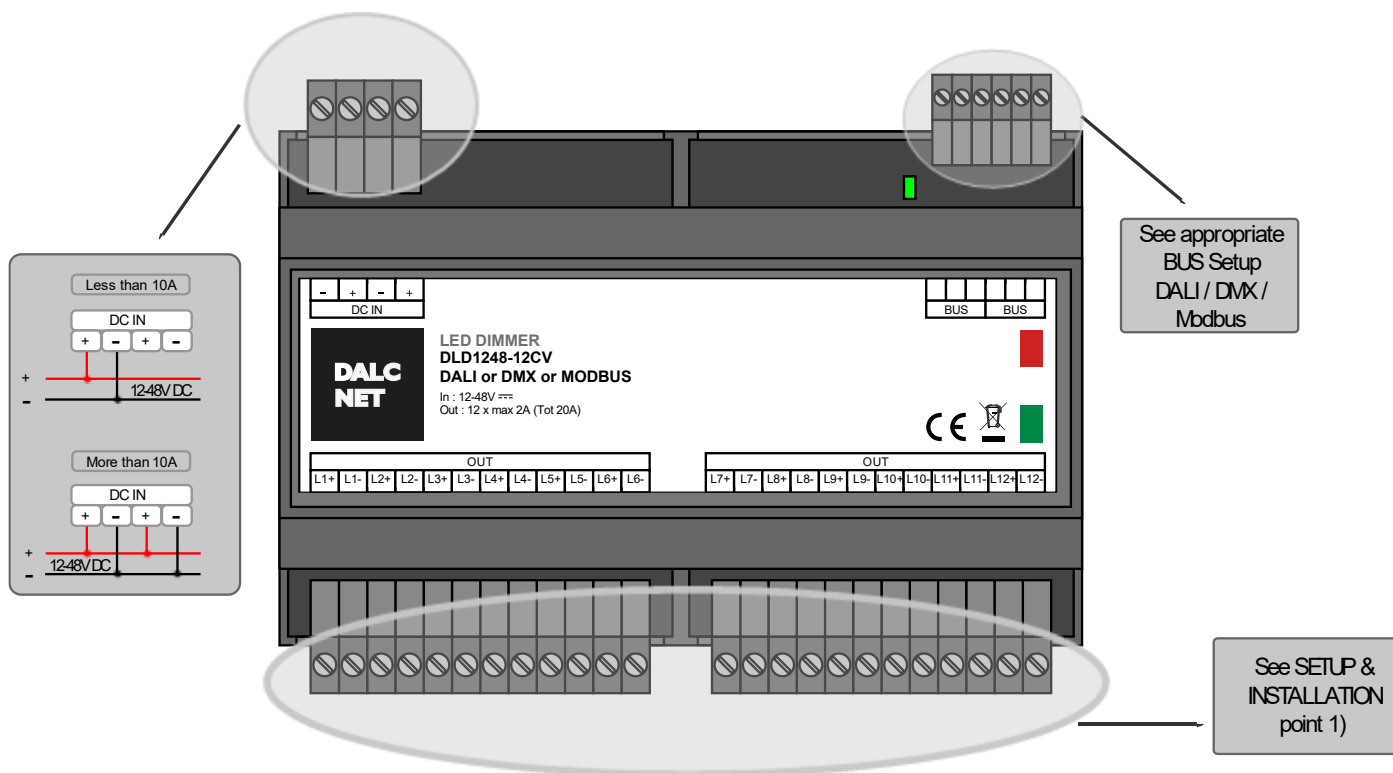

➤ **MECHANICAL DIMENSIONS:
(Without connectors)**

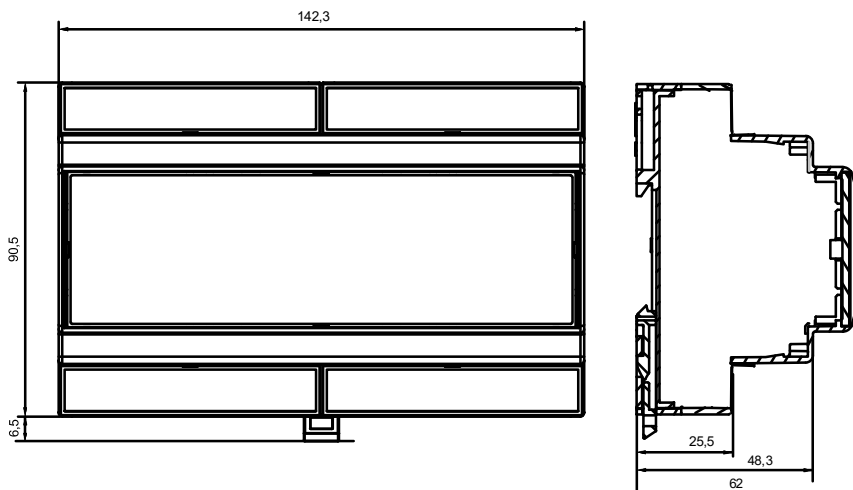

➤ OPENING THE COVER

For the Dip-switch and selectors configuration it is necessary to pull up the cover of the device. See the picture.

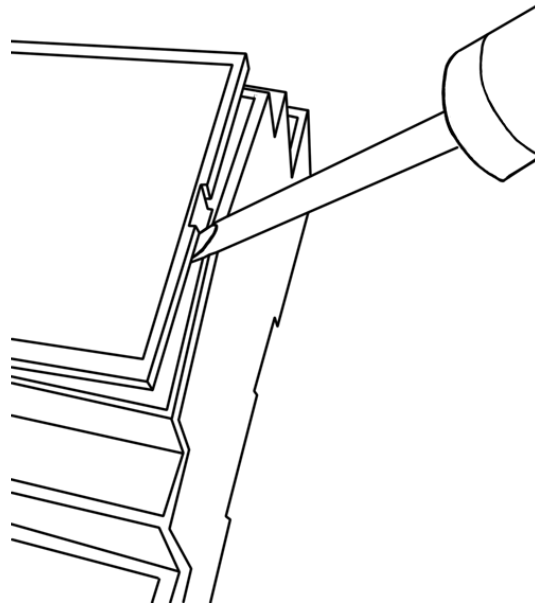

➤ TECHNICAL NOTES

Installation:

- Installation and maintenance must be performed only by qualified personnel in compliance with current regulations.
- The product must be installed inside an electrical panel protected against overvoltages.
- The product must be installed in a vertical or horizontal position with the cover / label upwards or vertically; Other positions are not permitted. It is not permitted to bottom-up position (with the cover / label updown).
- Keep separated the circuits at 230V (LV) and the circuits not SELV from circuits to low voltage (SELV) and from any connection with this product. It is absolutely forbidden to connect, for any reason whatsoever, directly or indirectly, the 230V mains voltage to the bus or to other parts of the circuit.

Power supply:

- For the power supply use only a SELV power supplies with limited current, short circuit protection and the power must be dimensioned correctly. In case of using power supply with ground terminals, all points of the protective earth (PE = Protection Earth) must be connected to a valid and certified protection earth.
- The connection cables between the power source "low voltage" and the product must be dimensioned correctly and they should be isolated from every wiring or parts at voltage not SELV. Use double insulated cables.
- In the event of higher than 10A total output current to plug into both power input pairs "V+" and "V-".
- Dimension the power supply for the load connected to the device. If the power supply is oversized compared with the maximum absorbed current, insert a protection against over-current between the power supply and the device.

Command:

- The length and type of bus cables (DMX512, Modbus, DALI or other) must comply with the specifications defined by the respective regulations and they should be isolated from every wiring or parts at voltage not SELV. Use double insulated shielded and twisted cables.
- All the product and the control signal to the bus (DMX512, Modbus, DALI or other) must be SELV (the devices connected must be SELV or otherwise provide a SELV)

Outputs:

- The length of the connection cables between the product and the LED module must be less than 10m; the cables must be dimensioned correctly and they should be isolated from every wiring or parts at voltage not SELV. Is preferable to use shielded and twisted cables.

➤ SETUP & INSTALLATION

A 12 way dip-switch (under the cover) can provide a rich set of possible configurations:

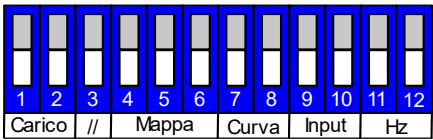

Note: Factory positions = all OFF

Function		<ul style="list-style-type: none"> Switches from 1 to 2: Switch 3: Switches from 4 to 6: Switches from 7 to 8: Switches from 9 to 10: Switches from 11 to 12: 	Load Type Parallel outputs Map Curve Reserved Output frame rate (freq.)
----------	---	---	--

1) Select Load Type and Management of Independent channels: Switches from 1 to 2. Dip 3 set to OFF

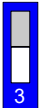

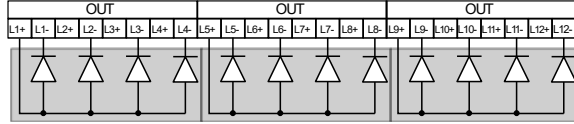
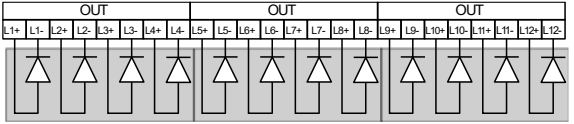
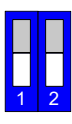

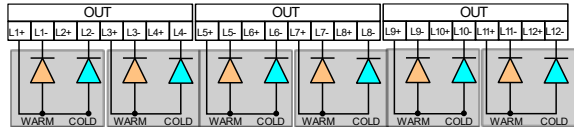
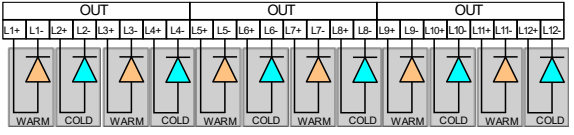
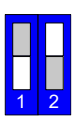
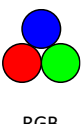
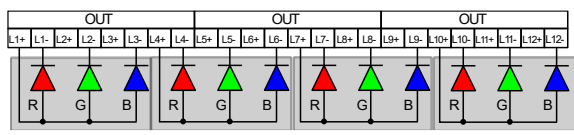
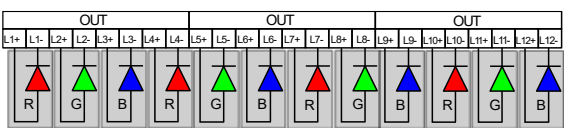
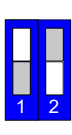
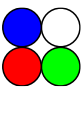
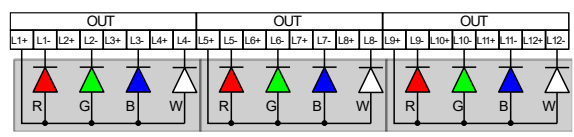
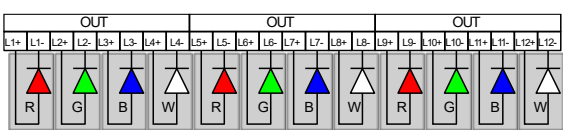
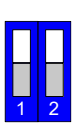

To manage independently channels, the Switch DIP 3 must be set to OFF:

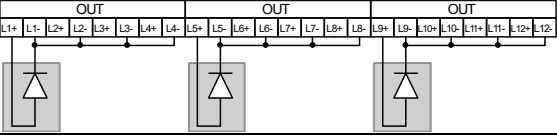
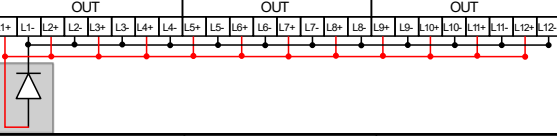
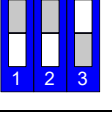

Load Type	Output connection at common anode (*) ⁴	Output connection on 12 independent anode (Current tot. 0-20A max)	DIP
 White			
 Tunable White			
 RGB			
 RGBW			

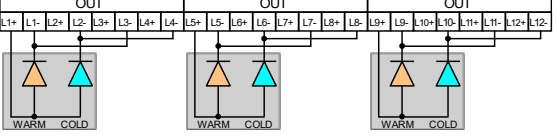
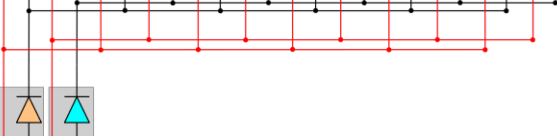
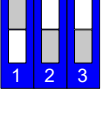

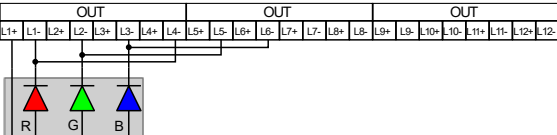
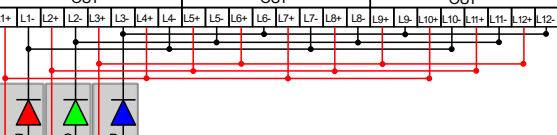
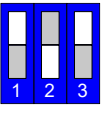

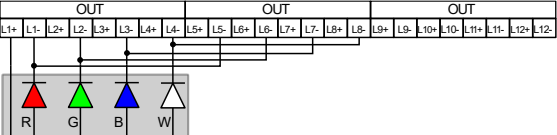
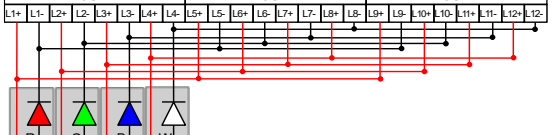
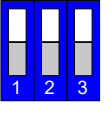
⁴ NOTE: The connection at common anode must not exceed 10A

Select Load Type and Parallel Out depending on output connections:
Switches from 1 to 2. Dip 3 set on ON

Load Type	Output connection at common anode (*)	Output connection on independent anode (current tot. 0-20A max)	DIP
			
			
			
			



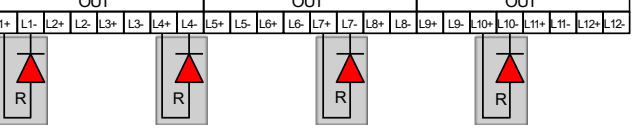
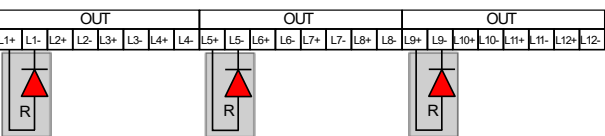
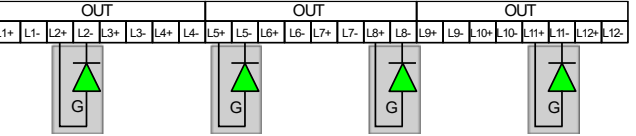
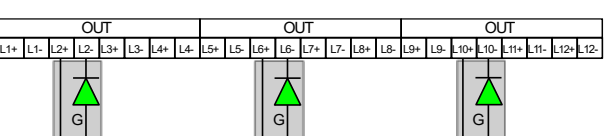
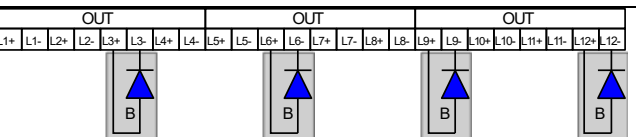
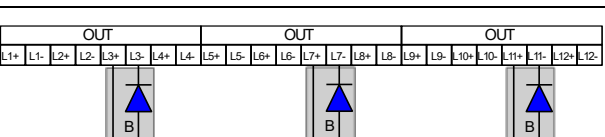

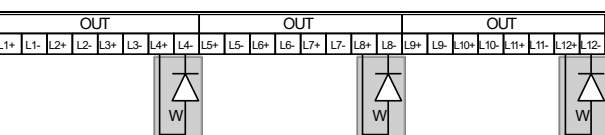
NOTE: With this setting it is possible to connect parallel out to get higher output current (Macro Dimmer). The connection at common anode must not exceed 10A. If you connect a higher load than 10A it is possible to connect all the negative outputs and positive output to get only one channel with more current intensity (depending on the current required) see the "Output connection on independent anode" column. The maximum current output is 20A.

In RGB and RGBW functions is possible to control all RED channels or all GREEN channels or all BLUE channels or all WHITE channels synchronously.

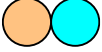

<p>RGB Function Synchronous control of single colors R, G and B</p> 	<p>RGBW Function Synchronous control of single colors R, G, B and W</p> 
	
	
	
	

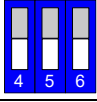
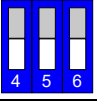
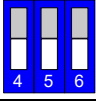
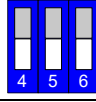
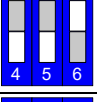
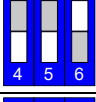
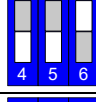
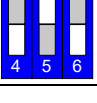
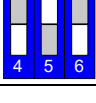
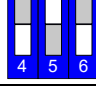
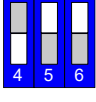
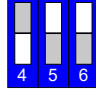
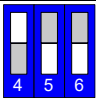
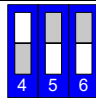
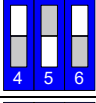
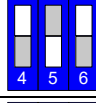
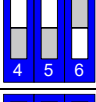
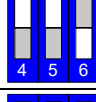

2) Select Map: Switches from 4 to 6

White Load 	Tunable White Load 	RGB Load 	RGBW Load 
Dimmer 	Dimmer 	Dimmer 	Dimmer 
	Dim to Warm 	Dim to Warm 	Dim to Warm 
	Tunable White 	Tunable White 	Tunable White 
		Smart HSV Intensity, temperature correction, color hue & rotation, saturation and strobe 	Smart HSV Intensity, temperature correction, color hue & rotation, saturation and strobe 
		RGB 	RGB Convert RGB→RGBW 
		RGBW Convert RGBW→RGB 	RGBW 
		Master+RGB+Strobe 	Master+RGB+Strobe Convert RGB→RGBW 
		Master+RGBW+Strobe Convert RGBW→RGB 	Master+RGBW+Strobe 

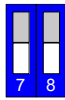
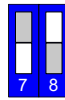
3) Select Dimming Curve: Switches from 7 to 8

Default (by bus type) 	Quadratic 	Exponential 	Linear 
---	--	--	--

4) Switches from 9 to 10: Configuration Reserved

5) Set output Frequency: Switches from 11 to 12

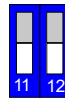
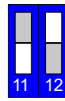
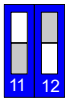
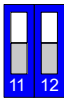
300Hz 	600Hz 	1200Hz 	Reserved 
--	--	---	--

➤ DALI BUS SETUP

In **DALI BUS SETUP** all the leds are controlled by an external DALI controller

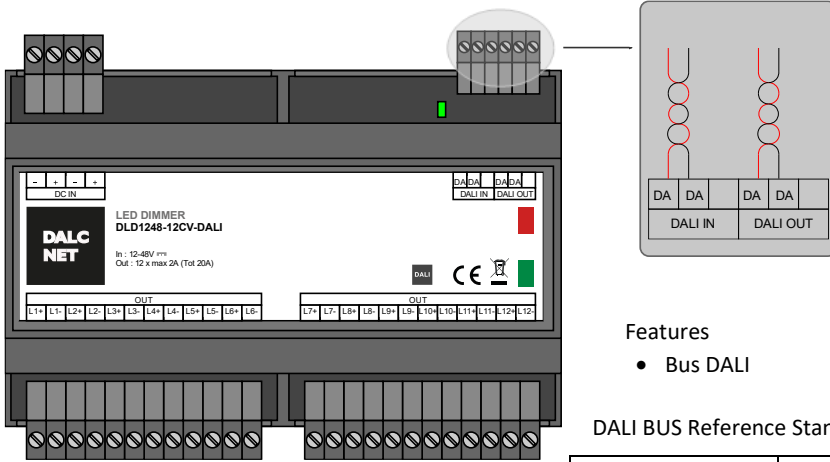

Features

- Bus DALI

DALI BUS Reference Standards







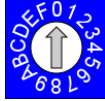

IEC/EN 62386-101	Digital addressable lighting interface – Part 101: General requirements - System
IEC/EN 62386-102	Digital addressable lighting interface – Part 102: General requirements – Control gear
IEC/EN 62386-207	Digital addressable lighting interface – Part 207: Particular requirements for control gear – LED modules (device type 6)

Onboard led:

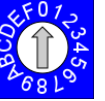
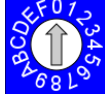
- In the case of no bus power detected, or bus error, the led blinks fast (2 pulsed per second).
- In the case of bus power but no data, led blinks slow (1 pulse per second).
- In the case of data link active, the led stands on.

Addressing:

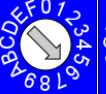
By selectors	✓
Simplified method (One ballast connected at time)	✓
Random Address Allocation	✓

DALI	000 (Default)					Address defined by DALI		
	from 001				to 064			



CHANNEL MAP – DALI

MAP: DIMMER

MAP	Function	
DIMMER	Dimmer	Dimmer (Brightness Value) 0 .. 254

ASSIGNMENT ADDRESSES DEPENDING ON TYPE OF LOAD: White, Tunable White, RGB and RGBW

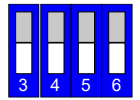
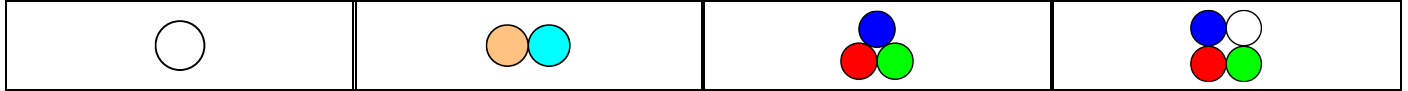

Management of single channel (DIP 3 set to "OFF")

Addr	Function	OUT	Addr	Function	OUT	Addr	Function	OUT	Addr	Function	OUT
+0	Dimmer	CH 1	+0	Dimmer	CH 1-2	+0	Dimmer	CH 1-3	+0	Dimmer	CH 4
+1	Dimmer	CH 2	+1	Dimmer	CH 3-4	+1	Dimmer	CH 4-6	+1	Dimmer	CH 8
+2	Dimmer	CH 3	+2	Dimmer	CH 5-6	+2	Dimmer	CH 7-9	+2	Dimmer	CH 12
+3	Dimmer	CH 4	+3	Dimmer	CH 7-8	+3	Dimmer	CH 10-12			
+4	Dimmer	CH 5	+4	Dimmer	CH 9-10						
+5	Dimmer	CH 6	+5	Dimmer	CH 11-12						
+6	Dimmer	CH 7									
+7	Dimmer	CH 8									
+8	Dimmer	CH 9									
+9	Dimmer	CH 10									
+10	Dimmer	CH 11									
+11	Dimmer	CH 12									

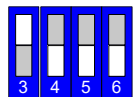

Management of parallel channels (DIP 3 set to "ON")

Addr	Function	OUT	Addr	Function	OUT	Addr	Function	OUT	Addr	Function	OUT
+0	Dimmer	ALL CH	+0	Dimmer	ALL CH	+0	Dimmer	ALL CH	+0	Dimmer	CH 4,8,12



MAP: DIM TO WARM

MAP	Function	
DIM TO WARM	Dim to warm	Dimmer (Brightness Value) 0 .. 254

ASSIGNMENT ADDRESSES DEPENDING ON TYPE OF LOAD: Tunable White, RGB and RGBW

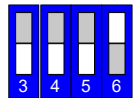
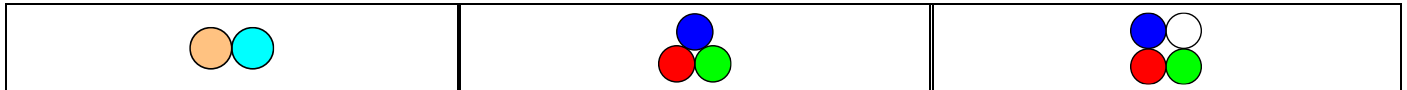

Management of single channel (DIP 3 set to "OFF")

Addr	Function	OUT	Addr	Function	OUT	Addr	Function	OUT
+0	Dim to warm	CH 1-2	+0	Dim to warm	CH 1,2,3	+0	Dim to warm	CH 1,2,3,4
+1	Dim to warm	CH 3-4	+1	Dim to warm	CH 4,5,6	+1	Dim to warm	CH 5,6,7,8
+2	Dim to warm	CH 5-6	+2	Dim to warm	CH 7,8,9	+2	Dim to warm	CH 9,10,11,12
+3	Dim to warm	CH 7-8	+3	Dim to warm	CH 10,11,12			
+4	Dim to warm	CH 9-10						
+5	Dim to warm	CH 11-12						

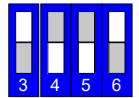

Management of parallel channels (DIP 3 set to "ON")

Addr	Function	OUT	Addr	Function	OUT	Addr	Function	OUT
+0	Dim to warm	ALL CH	+0	Dim to warm	ALL CH	+0	Dim to warm	ALL CH



MAP: TUNABLE WHITE

MAP	Function	
TUNABLE WHITE	Dimmer	Dimmer (Brightness Value) 0 .. 254
	CCT	Color Correction Temperature 0 ..254 (Valore 127 Bianco Neutro)

ASSIGNMENT ADDRESSES DEPENDING ON TYPE OF LOAD: Tunable White, RGB and RGBW

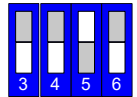
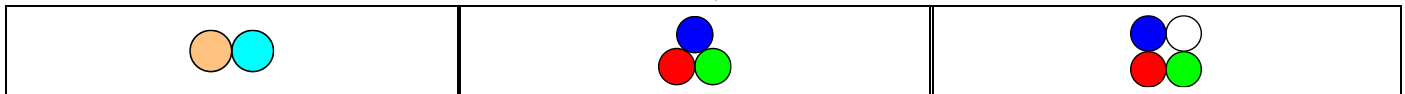

Management of single channel (DIP 3 set to "OFF")

Addr	Function	OUT	Addr	Function	OUT	Addr	Function	OUT
+0	Dimmer	CH 1-2	+0	Dimmer	CH 1-3	+0	Dimmer	CH 1-4
+1	CCT	CH 1-2	+1	CCT	CH 1-3	+1	CCT	CH 1-4
+2	Dimmer	CH 3-4	+2	Dimmer	CH 4-6	+2	Dimmer	CH 5-8
+3	CCT	CH 3-4	+3	CCT	CH 4-6	+3	CCT	CH 5-8
+4	Dimmer	CH 5-6	+4	Dimmer	CH 7-9	+4	Dimmer	CH 9-12
+5	CCT	CH 5-6	+5	CCT	CH 7-9	+5	CCT	CH 9-12
+6	Dimmer	CH 7-8	+6	Dimmer	CH 10-12			
+7	CCT	CH 7-8	+7	CCT	CH 10-12			
+8	Dimmer	CH 9-10						
+9	CCT	CH 9-10						
+10	Dimmer	CH 11-12						
+11	CCT	CH 11-12						

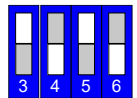

Management of parallel channels (DIP 3 set to "ON")

Addr	Function	OUT	Addr	Function	OUT	Addr	Function	OUT
+0	Dimmer	ALL CH	+0	Dimmer	ALL CH	+0	Dimmer	ALL CH
+1	CCT	ALL CH	+1	CCT	ALL CH	+1	CCT	ALL CH



MAP: SMART HSV

MAP	Function															
Smart SHV	Master Dimmer	Master Dimmer (Brightness Value) 0 .. 254														
	Color Correction	Color Temperature Correction 0 ..254														
	Hue	Hue 0 .. 254														
	Hue Rotation (rainbow) Time	Stop	0 .. 25	3s 26 .. 51	6s 52 .. 76	15s 77..102	30s 103..127	1' 128..153	3' 154..179	6' 180..204	15' 205..230	30' 231..254				
		Hue Fine	0 .. 15	Hold 16..25												
	Saturation	Saturation 0 .. 254														
Strobo Rate	steady 0..15	blackout 16..31	1fps 32..47	2fps 48..63	3fps 64..79	4fps 80..95	5fps 96..111	6fps 112..127	7fps 128..143	8fps 144..159	9fps 160..175	10fps 176..191	12fps 192..207	14fps 208..223	16fps 224..239	240..254

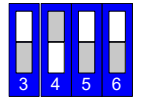
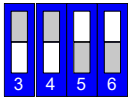

ASSIGNMENT ADDRESSES DEPENDING ON TYPE OF LOAD: RGB and RGBW

Management of single channel (DIP 3 set to "OFF")					
RGB			RGBW		
Addr	Function	OUT	Addr	Function	OUT
+0	DIMMER	CH 1,2,3	+0	DIMMER	CH 1,2,3,4
+1	CCT	CH 1,2,3	+1	CCT	CH 1,2,3,4
+2	HUE	CH 1,2,3	+2	HUE	CH 1,2,3,4
+3	Rainbow	CH 1,2,3	+3	Rainbow	CH 1,2,3,4
+4	Saturation	CH 1,2,3	+4	Saturation	CH 1,2,3,4
+5	Strobo	CH 1,2,3	+5	Strobo	CH 1,2,3,4
+6	DIMMER	CH 4,5,6	+6	DIMMER	CH 5,6,7,8
+7	CCT	CH 4,5,6	+7	CCT	CH 5,6,7,8
+8	HUE	CH 4,5,6	+8	HUE	CH 5,6,7,8
+9	Rainbow	CH 4,5,6	+9	Rainbow	CH 5,6,7,8
+10	Saturation	CH 4,5,6	+10	Saturation	CH 5,6,7,8
+11	Strobo	CH 4,5,6	+11	Strobo	CH 5,6,7,8
+12	DIMMER	CH 7,8,9	+12	DIMMER	CH 9,10,11,12
+13	CCT	CH 7,8,9	+13	CCT	CH 9,10,11,12
+14	HUE	CH 7,8,9	+14	HUE	CH 9,10,11,12
+15	Rainbow	CH 7,8,9	+15	Rainbow	CH 9,10,11,12
+16	Saturation	CH 7,8,9	+16	Saturation	CH 9,10,11,12
+17	Strobo	CH 7,8,9	+17	Strobo	CH 9,10,11,12
+18	DIMMER	CH 10,11,12			
+19	CCT	CH 10,11,12			
+20	HUE	CH 10,11,12			
+21	Rainbow	CH 10,11,12			
+22	Saturation	CH 10,11,12			
+23	Strobo	CH 10,11,12			

Management of parallel channels (DIP 3 set to "ON")					
RGB			RGBW		
Addr	Function	OUT	Addr	Function	OUT
+0	DIMMER	ALL CH	+0	DIMMER	ALL CH
+1	CCT	ALL CH	+1	CCT	ALL CH
+2	HUE	ALL CH	+2	HUE	ALL CH
+3	Rainbow	ALL CH	+3	Rainbow	ALL CH
+4	Saturation	ALL CH	+4	Saturation	ALL CH
+5	Strobo	ALL CH	+5	Strobo	ALL CH



MAP: RGB

MAP	Function	
RGB	R	Dimmer R (Brightness value) 0 .. 254
	G	Dimmer G (Brightness value) 0 .. 254
	B	Dimmer B (Brightness value) 0 .. 254

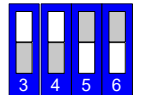
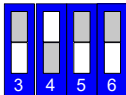

ASSIGNMENT ADDRESSES DEPENDING ON TYPE OF LOAD: RGB and RGBW

Management of single channel (DIP 3 set to "OFF")					
Addr	Function	OUT	Addr	Function	OUT
+0	R	CH 1	+0	R	CH 1
+1	G	CH 2	+1	G	CH 2
+2	B	CH 3	+2	B	CH 3
+3	R	CH 4	+3	R	CH 5
+4	G	CH 5	+4	G	CH 6
+5	B	CH 6	+5	B	CH 7
+6	R	CH 7	+6	R	CH 9
+7	G	CH 8	+7	G	CH 10
+8	B	CH 9	+8	B	CH 11
+9	R	CH 10			
+10	G	CH 11			
+11	B	CH 12			

Management of parallel channels (DIP 3 set to "ON")					
Addr	Function	OUT	Addr	Function	OUT
+0	R	CH 1,4,7,10	+0	R	CH 1,5,9
+1	G	CH 2,5,8,11	+1	G	CH 2,6,10
+2	B	CH 3,6,9,12	+2	B	CH 3,7,11



MAP: RGBW

MAP	Function	
RGBW	R	Dimmer R (Brightness Value) 0 .. 254
	G	Dimmer G (Brightness Value) 0 .. 254
	B	Dimmer B (Brightness Value) 0 .. 254
	W	Dimmer W (Brightness Value) 0 .. 254

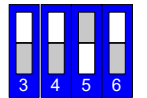
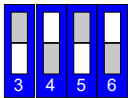

ASSIGNMENT ADDRESSES DEPENDING ON TYPE OF LOAD: RGB and RGBW

Management of single channels (DIP 3 set to "OFF")					
RGB			RGBW		
Addr	Function	OUT	Addr	Function	OUT
+0	R	CH 1	+0	R	CH 1
+1	G	CH 2	+1	G	CH 2
+2	B	CH 3	+2	B	CH 3
+3	W	CH 1-3	+3	W	CH 4
+4	R	CH 4	+4	R	CH 5
+5	G	CH 5	+5	G	CH 6
+6	B	CH 6	+6	B	CH 7
+7	W	CH 4-6	+7	W	CH 8
+8	R	CH 7	+8	R	CH 9
+9	G	CH 8	+9	G	CH 10
+10	B	CH 9	+10	B	CH 11
+11	W	CH 7-9	+11	W	CH 12
+12	R	CH 10			
+13	G	CH 11			
+14	B	CH 12			
+15	W	CH 10-12			

Management of parallel channels (DIP 3 set to "ON")					
RGB			RGBW		
Addr	Function	OUT	Addr	Function	OUT
+0	R	CH 1,4,7,10	+0	R	CH 1,5,9
+1	G	CH 2,5,8,11	+1	G	CH 2,6,10
+2	B	CH 3,6,9,12	+2	B	CH 3,7,11
+3	W	ALL CH	+3	W	ALL CH



MAP: MRGB+

MAP	Function																																
MRGB+	Master Dimmer	Master Dimmer (Brightness Value) 0 .. 254																															
	R	Dimmer R (Brightness Value) 0 .. 254																															
	G	Dimmer G (Brightness Value) 0 .. 254																															
	B	Dimmer B (Brightness Value) 0 .. 254																															
	Strobo Rate	<table border="1" style="font-size: small;"> <tr> <td>steady</td><td>blackout</td><td>1fps</td><td>2fps</td><td>3fps</td><td>4fps</td><td>5fps</td><td>6fps</td><td>7fps</td><td>8fps</td><td>9fps</td><td>10fps</td><td>12fps</td><td>14fps</td><td>16fps</td><td>steady</td> </tr> <tr> <td>0..15</td><td>16..31</td><td>32..47</td><td>48..63</td><td>64..79</td><td>80..95</td><td>96..111</td><td>112..127</td><td>128..143</td><td>144..159</td><td>160..175</td><td>176..191</td><td>192..207</td><td>208..223</td><td>224..239</td><td>240..254</td> </tr> </table>	steady	blackout	1fps	2fps	3fps	4fps	5fps	6fps	7fps	8fps	9fps	10fps	12fps	14fps	16fps	steady	0..15	16..31	32..47	48..63	64..79	80..95	96..111	112..127	128..143	144..159	160..175	176..191	192..207	208..223	224..239
steady	blackout	1fps	2fps	3fps	4fps	5fps	6fps	7fps	8fps	9fps	10fps	12fps	14fps	16fps	steady																		
0..15	16..31	32..47	48..63	64..79	80..95	96..111	112..127	128..143	144..159	160..175	176..191	192..207	208..223	224..239	240..254																		

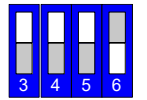
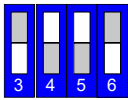

ASSIGNMENT ADDRESSES DEPENDING ON TYPE OF LOAD: RGB and RGBW

Management of single channels (DIP 3 set to "OFF")					
RGB			RGBW		
Addr	Function	OUT	Addr	Function	OUT
+0	MASTER DIMMER	CH 1-3	+0	MASTER DIMMER	CH 1-3
+1	R	CH 1	+1	R	CH 1
+2	G	CH 2	+2	G	CH 2
+3	B	CH 3	+3	B	CH 3
+4	STROBO RATE	CH 1-3	+4	STROBO RATE	CH 1-3
+5	MASTER DIMMER	CH 4-6	+5	MASTER DIMMER	CH 5-7
+6	R	CH 4	+6	R	CH 5
+7	G	CH 5	+7	G	CH 6
+8	B	CH 6	+8	B	CH 7
+9	STROBO RATE	CH 4-6	+9	STROBO RATE	CH 5-7
+10	MASTER DIMMER	CH 7-9	+10	MASTER DIMMER	CH 9-11
+11	R	CH 7	+11	R	CH 9
+12	G	CH 8	+12	G	CH 10
+13	B	CH 9	+13	B	CH 11
+14	STROBO RATE	CH 7-9	+14	STROBO RATE	CH 9-11
+15	MASTER DIMMER	CH 10-12			
+16	R	CH 10			
+17	G	CH 11			
+18	B	CH 12			
+19	STROBO RATE	CH 10-12			

Management of parallel channels (DIP 3 set to "ON")					
RGB			RGBW		
Addr	Function	OUT	Addr	Function	OUT
+0	MASTER DIMMER	ALL CH	+0	MASTER DIMMER	CH 1,2,3,5,6,7,9,10,11
+1	R	CH 1,4,7,10	+1	R	CH 1,5,9
+2	G	CH 2,5,8,11	+2	G	CH 2,6,10
+3	B	CH 3,6,9,12	+3	B	CH 3,7,11
+4	STROBO RATE	ALL CH	+4	STROBO RATE	CH 1,2,3,5,6,7,9,10,11



MAP: MRGBW+

MAP	Function																																
MRGBW+	Master Dimmer	Master Dimmer (Brightness Value) 0 .. 254																															
	R	Dimmer R (Brightness Value) 0 .. 254																															
	G	Dimmer G (Brightness Value) 0 .. 254																															
	B	Dimmer B (Brightness Value) 0 .. 254																															
	W	Dimmer W (Brightness Value) 0 .. 254																															
	Strobo Rate	Strobo Rate (Brightness Value) 0 .. 254																															
		<table border="1" style="font-size: small;"> <tr> <td>steady</td><td>blackout</td><td>1fps</td><td>2fps</td><td>3fps</td><td>4fps</td><td>5fps</td><td>6fps</td><td>7fps</td><td>8fps</td><td>9fps</td><td>10fps</td><td>12fps</td><td>14fps</td><td>16fps</td><td>steady</td> </tr> <tr> <td>0..15</td><td>16..31</td><td>32..47</td><td>48..63</td><td>64..79</td><td>80..95</td><td>96..111</td><td>112..127</td><td>128..143</td><td>144..159</td><td>160..175</td><td>176..191</td><td>192..207</td><td>208..223</td><td>224..239</td><td>240..254</td> </tr> </table>	steady	blackout	1fps	2fps	3fps	4fps	5fps	6fps	7fps	8fps	9fps	10fps	12fps	14fps	16fps	steady	0..15	16..31	32..47	48..63	64..79	80..95	96..111	112..127	128..143	144..159	160..175	176..191	192..207	208..223	224..239
steady	blackout	1fps	2fps	3fps	4fps	5fps	6fps	7fps	8fps	9fps	10fps	12fps	14fps	16fps	steady																		
0..15	16..31	32..47	48..63	64..79	80..95	96..111	112..127	128..143	144..159	160..175	176..191	192..207	208..223	224..239	240..254																		

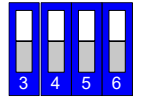
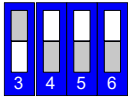

ASSIGNMENT ADDRESSES DEPENDING ON TYPE OF LOAD

Management of single channels (DIP 3 set to "OFF")					
Addr	Function	OUT	Addr	Function	OUT
+0	MASTER DIMMER	CH 1-3	+0	MASTER DIMMER	CH 1-4
+1	R	CH 1	+1	R	CH 1
+2	G	CH 2	+2	G	CH 2
+3	B	CH 3	+3	B	CH 3
+4	W	CH 1-3	+4	W	CH 4
+5	STROBO RATE	CH 1-3	+5	STROBO RATE	CH 1-4
+6	MASTER DIMMER	CH 4-6	+6	MASTER DIMMER	CH 5-8
+7	R	CH 4	+7	R	CH 5
+8	G	CH 5	+8	G	CH 6
+9	B	CH 6	+9	B	CH 7
+10	W	CH 4-6	+10	W	CH 8
+11	STROBO RATE	CH 4-6	+11	STROBO RATE	CH 5-8
+12	MASTER DIMMER	CH 7-9	+12	MASTER DIMMER	CH 9-12
+13	R	CH 7	+13	R	CH 9
+14	G	CH 8	+14	G	CH 10
+15	B	CH 9	+15	B	CH 11
+16	W	CH 7-9	+16	W	CH 12
+17	STROBO RATE	CH 7-9	+17	STROBO RATE	CH 9-12
+18	MASTER DIMMER	CH 10-12			
+19	R	CH 10			
+20	G	CH 11			
+21	B	CH 12			
+22	W	CH 10-12			
+23	STROBO RATE	CH 10-12			

Management of parallel channels (DIP 3 set to "ON")					
Addr	Function	OUT	Addr	Function	OUT
+0	MASTER DIMMER	ALL CH	+0	MASTER DIMMER	ALL CH
+1	R	CH 1,4,7,10	+1	R	CH 1,5,9
+2	G	CH 2,5,8,11	+2	G	CH 2,6,10
+3	B	CH 3,6,9,12	+3	B	CH 3,7,11
+4	W	ALL CH	+4	W	CH 4,8,9
+5	STROBO RATE	ALL CH	+5	STROBO RATE	ALL CH

DMX+RDM BUS SETUP

With the DMX+RDM BUS SETUP in the "slave" condition the outputs are managed by an external DMX controller.
In the "master" condition, the DMX+RDM allows the communications between devices.

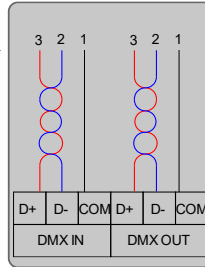
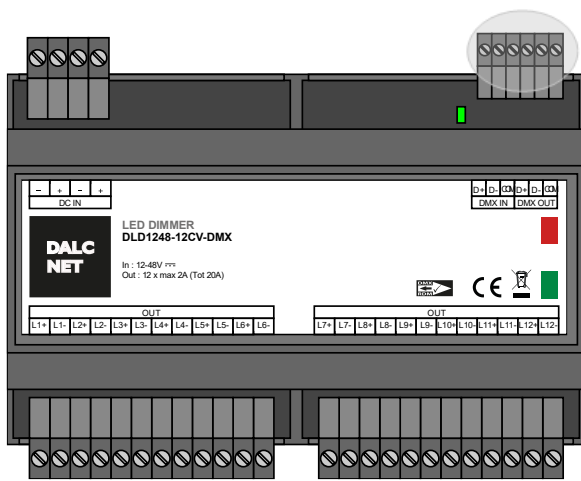

Use	3-Pin XLR Pin #	DMX512 Function
Common Reference	1	Data Link Common
Primary Data Link	2	Data 1-
	3	Data 1+
Secondary Data Link (Optional – see clause 4.8)	4	Data 2-
	5	Data 2+

Features

- BUS DMX512-A +RDM

DMX+RDM BUS Reference Standards

ANSI E1.11	Entertainment Technology – USITT DMX512-A – Asynchronous Serial Digital Data Transmission Standard for Controlling Lighting Equipment and Accessories
ANSI E1.20	Entertainment Technology-RDM-Remote Device Management over USITT DMX512 Networks

Technical Specification





Standard DMX512-A+RDM

Onboard led:

- In the case of bus error, the led blinks fast (2 pulsed per second).
- In the case of no bus detected, led blinks slow (1 pulse per second).
- In the case of data link active, the led stands on.

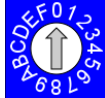
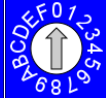
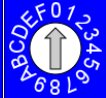
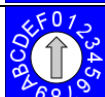
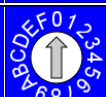
Addressing:

RDM	✓
By selectors	✓

DMX	000 (Deafault)					Addressing set by RDM protocol		
	from 001				to 512			



CHANNEL MAP – DMX512

MAP: DIMMER

MAP	Function	
DIMMER	Dimmer	Dimmer (Brightness Value) 0 .. 255

ASSIGNMENT ADDRESSES DEPENDING ON TYPE LOAD: Whitte, Tunable White, RGB and RGBW

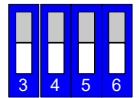
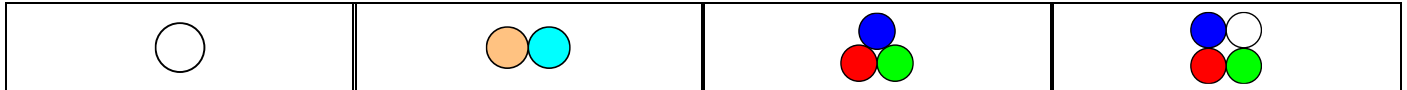

Management of single channels (DIP 3 set to "OFF")

Ch	Function	OUT	Ch	Function	OUT	Ch	Function	OUT	Ch	Function	OUT
1	Dimmer	CH 1	1	Dimmer	CH 1-2	1	Dimmer	CH 1-3	1	Dimmer	CH 1-4
2	Dimmer	CH 2	2	Dimmer	CH 3-4	2	Dimmer	CH 4-6	2	Dimmer	CH 5-8
3	Dimmer	CH 3	3	Dimmer	CH 5-6	3	Dimmer	CH 7-9	3	Dimmer	CH 9-12
4	Dimmer	CH 4	4	Dimmer	CH 7-8	4	Dimmer	CH 10-12			
5	Dimmer	CH 5	5	Dimmer	CH 9-10						
6	Dimmer	CH 6	6	Dimmer	CH 11-12						
7	Dimmer	CH 7									
8	Dimmer	CH 8									
9	Dimmer	CH 9									
10	Dimmer	CH 10									
11	Dimmer	CH 11									
12	Dimmer	CH 12									

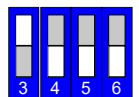

Management of parallel channels (DIP 3 set to "ON")

Ch	Function	OUT	Ch	Function	OUT	Ch	Function	OUT	Ch	Function	OUT
1	Dimmer	CH TUTTI	1	Dimmer	CH TUTTI	1	Dimmer	CH TUTTI	1	Dimmer	CH 4,8,12



MAP: DIM TO WARM

MAP	Function	
DIM TO WARM	Dim to warm	Dimmer (Brightness Value) 0 .. 255

ASSIGNMENT ADDRESSES DEPENDING ON TYPE OF LOAD: Tunable White, RGB and RGBW

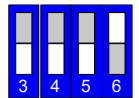
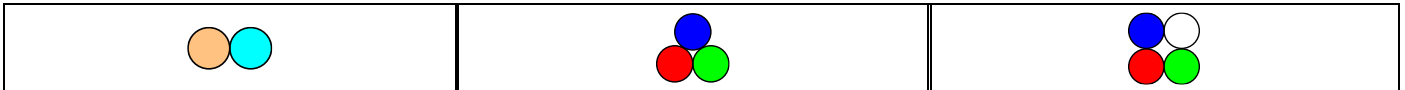

Management of single channels (DIP 3 set to "OFF")								
Ch	Function	OUT	Ch	Function	OUT	Ch	Function	OUT
1	Dim to warm	CH 1-2	1	Dim to warm	CH 1,2,3	1	Dim to warm	CH 1,2,3,4
2	Dim to warm	CH 3-4	2	Dim to warm	CH 4,5,6	2	Dim to warm	CH 5,6,7,8
3	Dim to warm	CH 5-6	3	Dim to warm	CH 7,8,9	3	Dim to warm	CH 9,10,11,12
4	Dim to warm	CH 7-8	4	Dim to warm	CH 10,11,12			
5	Dim to warm	CH 9-10						
6	Dim to warm	CH 11-12						

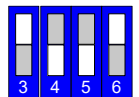

Management of parallel channels (DIP 3 set to "ON")								
Ch	Function	OUT	Ch	Function	OUT	Ch	Function	OUT
1	Dim to warm	ALL CH	1	Dim to warm	ALL CH	1	Dim to warm	ALL CH



MAP: TUNABLE WHITE

MAP	Function	
TUNABLE WHITE	Dimmer	Dimmer (Brightness Value) 0 .. 255
	CCT	Color Connection Temperature 0 ..255 (Value 127 Neutral White)

ASSIGNMENT ADDRESSES DEPENDING ON TYPE OF LOAD: Tunable White, RGB and RGBW

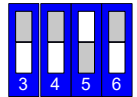
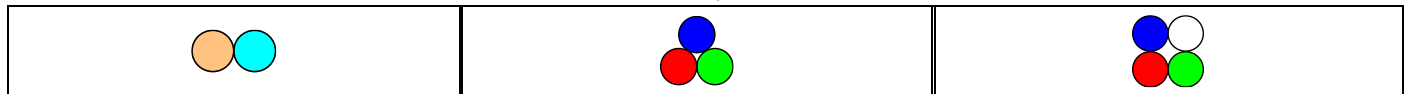

Management of single channels (DIP 3 set to "OFF")

Ch	Function	OUT	Ch	Function	OUT	Ch	Function	OUT
1	Dimmer	CH 1-2	1	Dimmer	CH 1-3	1	Dimmer	CH 1-4
2	CCT	CH 1-2	2	CCT	CH 1-3	2	CCT	CH 1-4
3	Dimmer	CH 3-4	3	Dimmer	CH 4-6	3	Dimmer	CH 5-8
4	CCT	CH 3-4	4	CCT	CH 4-6	4	CCT	CH 5-8
5	Dimmer	CH 5-6	5	Dimmer	CH 7-9	5	Dimmer	CH 9-12
6	CCT	CH 5-6	6	CCT	CH 7-9	6	CCT	CH 9-12
7	Dimmer	CH 7-8	7	Dimmer	CH 10-12			
8	CCT	CH 7-8	8	CCT	CH 10-12			
9	Dimmer	CH 9-10						
10	CCT	CH 9-10						
11	Dimmer	CH 11-12						
12	CCT	CH 11-12						

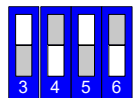

Management of parallel channels (DIP 3 set to "ON")

Ch	Funzione	OUT	Ch	Funzione	OUT	Ch	Funzione	OUT
1	Dimmer	ALL CH	1	Dimmer	ALL CH	1	Dimmer	ALL CH
2	CCT	ALL CH	2	CCT	ALL CH	2	CCT	ALL CH



MAP: SMART HSV

MAP	Function																														
Smart SHV	Master Dimmer	Master Dimmer (Brightness Value) 0 .. 255																													
	Color Correction	Color Temperature Connection 0 ..255																													
	Hue	Hue 0 .. 255																													
	Hue Rotation (rainbow) Time	Stop	0 .. 25	3s	26 .. 51	6s	52 .. 76	15s	77..102	30s	103..127	1'	128..153	3'	154..179	6'	180..204	15'	205..230	30'	231..254										
		Hue Fine	0 .. 15	Hold	16..25																										
	Saturation	Saturation 0 .. 255																													
Strobo Rate	steady	0..15	blackout	16..31	1fps	32..47	2fps	48..63	3fps	64..79	4fps	80..95	5fps	96..111	6fps	112..127	7fps	128..143	8fps	144..159	9fps	160..175	10fps	176..191	12fps	192..207	14fps	208..223	16fps	224..239	240..254

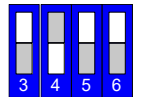
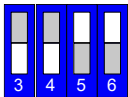

ASSIGNMENT ADDRESSES DEPENDING ON TYPE OF LOAD: RGB and RGBW

Management of single channels (DIP 3 set to "OFF")					
RGB			RGBW		
Ch	Function	OUT	Ch	Function	OUT
1	DIMMER	CH 1,2,3	1	DIMMER	CH 1,2,3,4
2	CCT	CH 1,2,3	2	CCT	CH 1,2,3,4
3	HUE	CH 1,2,3	3	HUE	CH 1,2,3,4
4	Rainbow	CH 1,2,3	4	Rainbow	CH 1,2,3,4
5	Saturation	CH 1,2,3	5	Saturation	CH 1,2,3,4
6	Strobo	CH 1,2,3	6	Strobo	CH 1,2,3,4
7	DIMMER	CH 4,5,6	7	DIMMER	CH 5,6,7,8
8	CCT	CH 4,5,6	8	CCT	CH 5,6,7,8
9	HUE	CH 4,5,6	9	HUE	CH 5,6,7,8
10	Rainbow	CH 4,5,6	10	Rainbow	CH 5,6,7,8
11	Saturation	CH 4,5,6	11	Saturation	CH 5,6,7,8
12	Strobo	CH 4,5,6	12	Strobo	CH 5,6,7,8
13	DIMMER	CH 7,8,9	13	DIMMER	CH 9,10,11,12
14	CCT	CH 7,8,9	14	CCT	CH 9,10,11,12
15	HUE	CH 7,8,9	15	HUE	CH 9,10,11,12
16	Rainbow	CH 7,8,9	16	Rainbow	CH 9,10,11,12
17	Saturation	CH 7,8,9	17	Saturation	CH 9,10,11,12
18	Strobo	CH 7,8,9	18	Strobo	CH 9,10,11,12
19	DIMMER	CH 10,11,12			
20	CCT	CH 10,11,12			
21	HUE	CH 10,11,12			
22	Rainbow	CH 10,11,12			
23	Saturation	CH 10,11,12			
24	Strobo	CH 10,11,12			

Management of parallel channels (DIP 3 set to "ON")					
RGB			RGBW		
Ch	Function	OUT	Ch	Function	OUT
1	DIMMER	ALL CH	1	DIMMER	ALL CH
2	CCT	ALL CH	2	CCT	ALL CH
3	HUE	ALL CH	3	HUE	ALL CH
4	Rainbow	ALL CH	4	Rainbow	ALL CH
5	Saturation	ALL CH	5	Saturation	ALL CH
6	Strobo	ALL CH	6	Strobo	ALL CH



MAP: RGB

MAP	Function	
RGB	R	Dimmer R (Brightness Value) 0 .. 255
	G	Dimmer G (Brightness Value) 0 .. 255
	B	Dimmer B (Brightness Value) 0 .. 255

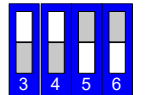
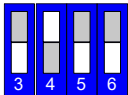

ASSIGNMENT ADDRESSES DEPENDING ON TYPE OF LOAD: RGB and RGBW

Management of single channels (DIP 3 set to "OFF")					
RGB			RGBW		
Ch	Function	OUT	Ch	Function	OUT
1	R	CH 1	1	R	CH 1
2	G	CH 2	2	G	CH 2
3	B	CH 3	3	B	CH 3
4	R	CH 4	4	R	CH 5
5	G	CH 5	5	G	CH 6
6	B	CH 6	6	B	CH 7
7	R	CH 7	7	R	CH 9
8	G	CH 8	8	G	CH 10
9	B	CH 9	9	B	CH 11
10	R	CH 10			
11	G	CH 11			
12	B	CH 12			

Management of parallel channels (DIP 3 set to "ON")					
RGB			RGBW		
Ch	Function	OUT	Ch	Function	OUT
1	R	CH 1,4,7,10	1	R	CH 1,5,9
2	G	CH 2,5,8,11	2	G	CH 2,6,10
3	B	CH 3,6,9,12	3	B	CH 3,7,11



MAP: RGBW

MAP	Function	
RGBW	R	Dimmer R (Brightness Value) 0 .. 255
	G	Dimmer G (Brightness Value) 0 .. 255
	B	Dimmer B (Brightness Value) 0 .. 255
	W	Dimmer W (Brightness Value) 0 .. 255

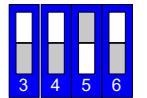
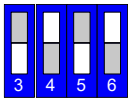

ASSIGNMENT ADDRESSES DEPENDING ON TYPE OF LOAD: RGB and RGBW

Management of single channels (DIP 3 set to "OFF")					
RGB			RGBW		
Ch	Function	OUT	Ch	Function	OUT
1	R	CH 1	1	R	CH 1
2	G	CH 2	2	G	CH 2
3	B	CH 3	3	B	CH 3
4	W	CH 1-3	4	W	CH 4
5	R	CH 4	5	R	CH 5
6	G	CH 5	6	G	CH 6
7	B	CH 6	7	B	CH 7
8	W	CH 4-6	8	W	CH 8
9	R	CH 7	9	R	CH 9
10	G	CH 8	10	G	CH 10
11	B	CH 9	11	B	CH 11
12	W	CH 7-9	12	W	CH 12
13	R	CH 10			
14	G	CH 11			
15	B	CH 12			
16	W	CH 10-12			

Management of parallel channels (DIP 3 set to "ON")					
RGB			RGBW		
Ch	Function	OUT	Ch	Function	OUT
1	R	CH 1,4,7,10	1	R	CH 1,5,9
2	G	CH 2,5,8,11	2	G	CH 2,6,10
3	B	CH 3,6,9,12	3	B	CH 3,7,11
4	W	ALL CH	4	W	ALL CH



MAP: MRGB+

MAP	Function																																
MRGB+	Master Dimmer	Master Dimmer (Brightness Value) 0 .. 255																															
	R	Dimmer R (Brightness Value) 0 .. 255																															
	G	Dimmer G (Brightness Value) 0 .. 255																															
	B	Dimmer B (Brightness Value) 0 .. 255																															
	Strobo Rate	<table border="1" style="font-size: small;"> <tr> <td>steady</td><td>blackout</td><td>1fps</td><td>2fps</td><td>3fps</td><td>4fps</td><td>5fps</td><td>6fps</td><td>7fps</td><td>8fps</td><td>9fps</td><td>10fps</td><td>12fps</td><td>14fps</td><td>16fps</td><td>steady</td> </tr> <tr> <td>0..15</td><td>16..31</td><td>32..47</td><td>48..63</td><td>64..79</td><td>80..95</td><td>96..111</td><td>112..127</td><td>128..143</td><td>144..159</td><td>160..175</td><td>176..191</td><td>192..207</td><td>208..223</td><td>224..239</td><td>240..254</td> </tr> </table>	steady	blackout	1fps	2fps	3fps	4fps	5fps	6fps	7fps	8fps	9fps	10fps	12fps	14fps	16fps	steady	0..15	16..31	32..47	48..63	64..79	80..95	96..111	112..127	128..143	144..159	160..175	176..191	192..207	208..223	224..239
steady	blackout	1fps	2fps	3fps	4fps	5fps	6fps	7fps	8fps	9fps	10fps	12fps	14fps	16fps	steady																		
0..15	16..31	32..47	48..63	64..79	80..95	96..111	112..127	128..143	144..159	160..175	176..191	192..207	208..223	224..239	240..254																		

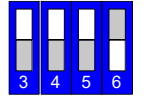
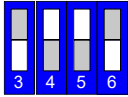

ASSIGNMENT ADDRESSES DEPENDING ON TYPE OF LOAD: RGB and RGBW

Management of single channels (DIP 3 set to "OFF")					
RGB			RGBW		
Ch	Function	OUT	Ch	Function	OUT
1	MASTER DIMMER	CH 1-3	1	MASTER DIMMER	CH 1-3
2	R	CH 1	2	R	CH 1
3	G	CH 2	3	G	CH 2
4	B	CH 3	4	B	CH 3
5	STROBO RATE	CH 1-3	5	STROBO RATE	CH 1-3
6	MASTER DIMMER	CH 4-6	6	MASTER DIMMER	CH 5-7
7	R	CH 4	7	R	CH 5
8	G	CH 5	8	G	CH 6
9	B	CH 6	9	B	CH 7
10	STROBO RATE	CH 4-6	10	STROBO RATE	CH 5-7
11	MASTER DIMMER	CH 7-9	11	MASTER DIMMER	CH 9-11
12	R	CH 7	12	R	CH 9
13	G	CH 8	13	G	CH 10
14	B	CH 9	14	B	CH 11
15	STROBO RATE	CH 7-9	15	STROBO RATE	CH 9-11
16	MASTER DIMMER	CH 10-12			
17	R	CH 10			
18	G	CH 11			
19	B	CH 12			
20	STROBO RATE	CH 10-12			

Management of parallel channels (DIP 3 set to "ON")					
RGB			RGBW		
Ch	Function	OUT	Ch	Function	OUT
1	MASTER DIMMER	CH TUTTI	1	MASTER DIMMER	CH 1,2,3,5,6,7,9,10,11
2	R	CH 1,4,7,10	2	R	CH 1,5,9
3	G	CH 2,5,8,11	3	G	CH 2,6,10
4	B	CH 3,6,9,12	4	B	CH 3,7,11
5	STROBO RATE	ALL CH	5	STROBO RATE	CH 1,2,3,5,6,7,9,10,11



MAP: MRGBW+

MAP	Function																																	
MRGBW+	Master Dimmer	Master Dimmer (Brightness Value) 0 .. 255																																
	R	Dimmer R (Brightness Value) 0 .. 255																																
	G	Dimmer G (Brightness Value) 0 .. 255																																
	B	Dimmer B (Brightness Value) 0 .. 255																																
	W	Dimmer W (Brightness Value) 0 .. 255																																
	Strobo Rate	<table border="1" style="width: 100%; text-align: center;"> <tr> <td>steady</td><td>blackout</td><td>1fps</td><td>2fps</td><td>3fps</td><td>4fps</td><td>5fps</td><td>6fps</td><td>7fps</td><td>8fps</td><td>9fps</td><td>10fps</td><td>12fps</td><td>14fps</td><td>16fps</td><td>steady</td> </tr> <tr> <td>0..15</td><td>16..31</td><td>32..47</td><td>48..63</td><td>64..79</td><td>80..95</td><td>96..111</td><td>112..127</td><td>128..143</td><td>144..159</td><td>160..175</td><td>176..191</td><td>192..207</td><td>208..223</td><td>224..239</td><td>240..254</td> </tr> </table>	steady	blackout	1fps	2fps	3fps	4fps	5fps	6fps	7fps	8fps	9fps	10fps	12fps	14fps	16fps	steady	0..15	16..31	32..47	48..63	64..79	80..95	96..111	112..127	128..143	144..159	160..175	176..191	192..207	208..223	224..239	240..254
	steady	blackout	1fps	2fps	3fps	4fps	5fps	6fps	7fps	8fps	9fps	10fps	12fps	14fps	16fps	steady																		
0..15	16..31	32..47	48..63	64..79	80..95	96..111	112..127	128..143	144..159	160..175	176..191	192..207	208..223	224..239	240..254																			

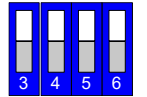
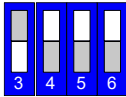

ASSIGNMENT ADDRESSES DEPENDING ON TYPE OF LOAD: RGB and RGBW

Management of single channels (DIP 3 set to "OFF")					
Ch	Function	OUT	Ch	Function	OUT
1	MASTER DIMMER	CH 1-3	1	MASTER DIMMER	CH 1-4
2	R	CH 1	2	R	CH 1
3	G	CH 2	3	G	CH 2
4	B	CH 3	4	B	CH 3
5	W	CH 1-3	5	W	CH 4
6	STROBO RATE	CH 1-3	6	STROBO RATE	CH 1-4
7	MASTER DIMMER	CH 4-6	7	MASTER DIMMER	CH 5-8
8	R	CH 4	8	R	CH 5
9	G	CH 5	9	G	CH 6
10	B	CH 6	10	B	CH 7
11	W	CH 4-6	11	W	CH 8
12	STROBO RATE	CH 4-6	12	STROBO RATE	CH 5-8
13	MASTER DIMMER	CH 7-9	13	MASTER DIMMER	CH 9-12
14	R	CH 7	14	R	CH 9
15	G	CH 8	15	G	CH 10
16	B	CH 9	16	B	CH 11
17	W	CH 7-9	17	W	CH 12
18	STROBO RATE	CH 7-9	18	STROBO RATE	CH 9-12
19	MASTER DIMMER	CH 10-12			
20	R	CH 10			
21	G	CH 11			
22	B	CH 12			
23	W	CH 10-12			
24	STROBO RATE	CH 10-12			

Management of parallel channels (DIP 3 set to "ON")					
Ch	Function	OUT	Ch	Function	OUT
1	MASTER DIMMER	CH TUTTI	1	MASTER DIMMER	CH TUTTI
2	R	CH 1,4,7,10	2	R	CH 1,5,9
3	G	CH 2,5,8,11	3	G	CH 2,6,10
4	B	CH 3,6,9,12	4	B	CH 3,7,11
5	W	ALL CH	5	W	CH 4,8,9
6	STROBO RATE	ALL CH	6	STROBO RATE	ALL CH





➤ RDM COMMANDS

<i>PARAMETRI NECESSARI</i>	
DISC_UNIQUE_BRANCH	✓
DISC_MUTE	✓
DISC_UN_MUTE	✓
SUPPORTED_PARAMETERS	✓
PARAMETERS_DESCRIPTION	✓
DEVICE_INFO	✓
SOFTWARE_VERSION_LABEL	✓
DMX_START_ADDRESS	✓
IDENTIFY_DEVICE	✓

<i>PARAMETRI SUPPORTATI</i>	
PRODUCT_DETAIL_ID_LIST	✓
DEVICE_MODEL_DESCRIPTION	✓
MANUFACTURER_LABEL	✓
DEVIDE_LABEL	✓
BOOT_SOFTWARE_VERSION_ID	✓
BOOT_SOFTWARE_VERSION_LABEL	✓
DMX_PERSONALITY	✓
DMX_PERSONALITY_DESCRIPTION	✓
SLOT_INFO	✓
SLOT_DESCRIPTION	✓
DEFAULT_SLOT_VALUE	✓

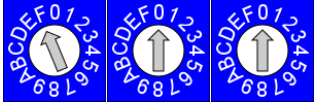
➤ **FADE UP / FADE DOWN:**

from F00		to FFF		<p>MASTER with Fade: Selector "x10" = UP fade time Selector "x1" = DOWN fade time</p> <p>0 = no Fade, F=60 seconds (see table)</p>
-------------	---	-----------	--	--

Fade Times:

0	1	2	3	4	5	6	7	8	9	A	B	C	D	E	F
NO fade	0.5s	1s	2s	3s	4s	5s	6s	7s	8s	9s	10s	15s	20s	30s	60s

Examples:

Turn on/off without fade (no Fade UP/DOWN): F00

Turn on without fade (no Fade UP) and turn off fade of 5 seconds (fade DOWN): F06

Turn on fade of 1 second (Fade UP) and turn off fade of 10 seconds (Fade DOWN): F2B

Notes:

This function is available on maps: "Dimmer", "Dim to Warm", "Tunable White", "Smart HSV"

➤ MODBUS SETUP

In MODBUS SETUP in the "slave" condition the outputs LEDs are managed by an external MODBUS RTU master control (RS-485).

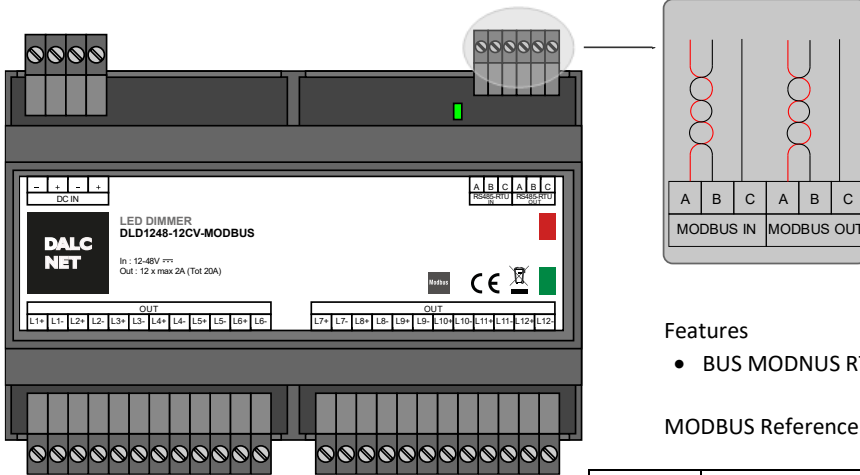

Features

- BUS MODBUS RTU SLAVE su RS485

MODBUS Reference Standards

- MODBUS APPLICATION PROTOCOL SPECIFICATION V1.1b

Notes:

The device does not polarize and there isn't implemented the ability to polarize the BUS.

In this case the polarization of the BUS must be implemented externally.

The polarization of the BUS can be carried out by the Master Modbus or on the terminals of the device. If the polarization of the BUS is carried out by Master or on the terminal of the device, no device present on the BUS must implement any polarization.

For more information see the MODBUS specification "[MODBUS over serial line specification and implementation guide V1.02](#)".





Onboard led:





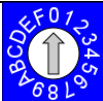
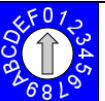

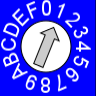

In the case of bus error, the led blinks fast (2 pulsed per second).

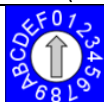
In the case of no bus detected, led blinks slow (1 pulse per second).

In the case of data link active, the led stands on.

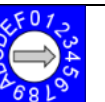
Addressing by selectors:

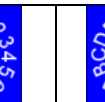
Selectors x10, x1 (middle and right)					
Modbus	00 (Default)				Default modbus ID (1)
	from 01			to 99	 

Selector x100 (left)								
Modbus								
	0	1	2	3	4	5	6	7
	115200 baud	115200 baud	38400 baud	38400 baud	19200 baud	19200 baud	9600 baud	9600 baud
	8N1	8E1	8N1	8E1	8N1	8E1	8N1	8E1



CHANNELS MAP – DMX512

MAP: DIMMER

MAP	Function	
DIMMER	Dimmer	Dimmer (Brightness Value) 0 .. 255

ASSIGNMENT ADDRESSES DEPENDIING ON TYPE OF LOAD: White, Tunable White, RGB and RGBW

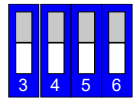
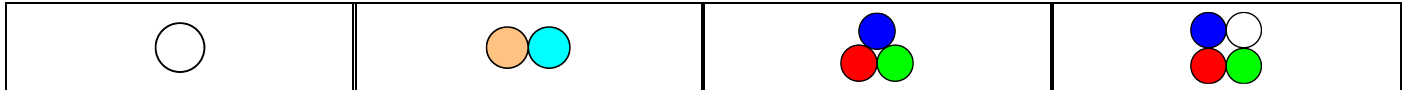

Management of single channels (DIP 3 set to "OFF")

Var	Function	OUT	Var	Function	OUT	Var	Function	OUT	Var	Function	OUT
0	Dimmer	CH 1	0	Dimmer	CH 1-2	0	Dimmer	CH 1-3	0	Dimmer	CH 1-4
1	Dimmer	CH 2	1	Dimmer	CH 3-4	1	Dimmer	CH 4-6	1	Dimmer	CH 5-8
2	Dimmer	CH 3	2	Dimmer	CH 5-6	2	Dimmer	CH 7-9	2	Dimmer	CH 9-12
3	Dimmer	CH 4	3	Dimmer	CH 7-8	3	Dimmer	CH 10-12			
4	Dimmer	CH 5	4	Dimmer	CH 9-10						
5	Dimmer	CH 6	5	Dimmer	CH 11-12						
6	Dimmer	CH 7									
7	Dimmer	CH 8									
8	Dimmer	CH 9									
9	Dimmer	CH 10									
10	Dimmer	CH 11									
11	Dimmer	CH 12									

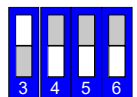

Management of parallel channels (DIP 3 set to "ON")

Var	Function	OUT	Var	Function	OUT	Var	Function	OUT	Var	Function	OUT
0	Dimmer	ALL CH	0	Dimmer	ALL CH	0	Dimmer	ALL CH	0	Dimmer	CH 4,8,12



MAP: DIM TO WARM

MAP	Function	
DIM TO WARM	Dim to warm	Dimmer (Brightness Value) 0 .. 255

ASSIGNMENT ADDRESSES DEPENDIING ON TYPE OF LOAD: Tunable White, RGB and RGBW

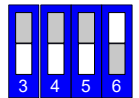
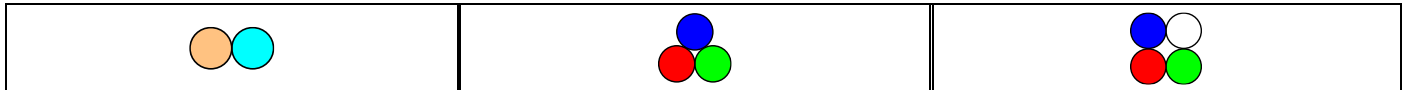

Management of single channels (DIP 3 set to "OFF")								
Var	Function	OUT	Var	Function	OUT	Var	Function	OUT
0	Dim to warm	CH 1-2	0	Dim to warm	CH 1,2,3	0	Dim to warm	CH 1,2,3,4
1	Dim to warm	CH 3-4	1	Dim to warm	CH 4,5,6	1	Dim to warm	CH 5,6,7,8
2	Dim to warm	CH 5-6	2	Dim to warm	CH 7,8,9	2	Dim to warm	CH 9,10,11,12
3	Dim to warm	CH 7-8	3	Dim to warm	CH 10,11,12			
4	Dim to warm	CH 9-10						
5	Dim to warm	CH 11-12						

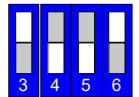

Management of parallel channels (DIP 3 set to "ON")								
Var	Function	OUT	Var	Function	OUT	Var	Function	OUT
0	Dim to warm	ALL CH	0	Dim to warm	ALL CH	0	Dim to warm	ALL CH



MAP: TUNABLE WHITE

MAP	Function	
TUNABLE WHITE	Dimmer	Dimmer (Brightness Value) 0 .. 255
	CCT	Color Correction Temperature 0 ..255 (Value 127 Natural White)

ASSIGNMENT ADDRESSES DEPENDIING ON TYPE OF LOAD: Tunable White, RGB and RGBW

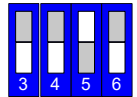
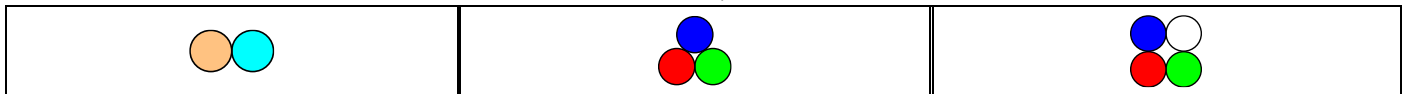

Management of single channels (DIP 3 set to "OFF")

Var	Function	OUT	Var	Function	OUT	Var	Function	OUT
0	Dimmer	CH 1-2	0	Dimmer	CH 1-3	0	Dimmer	CH 1-4
1	CCT	CH 1-2	1	CCT	CH 1-3	1	CCT	CH 1-4
2	Dimmer	CH 3-4	2	Dimmer	CH 4-6	2	Dimmer	CH 5-8
3	CCT	CH 3-4	3	CCT	CH 4-6	3	CCT	CH 5-8
4	Dimmer	CH 5-6	4	Dimmer	CH 7-9	4	Dimmer	CH 9-12
5	CCT	CH 5-6	5	CCT	CH 7-9	5	CCT	CH 9-12
6	Dimmer	CH 7-8	6	Dimmer	CH 10-12			
7	CCT	CH 7-8	7	CCT	CH 10-12			
8	Dimmer	CH 9-10						
9	CCT	CH 9-10						
10	Dimmer	CH 11-12						
11	CCT	CH 11-12						

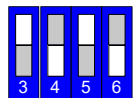

Management of parallel channels (DIP 3 set to "ON")

Var	Function	OUT	Var	Function	OUT	Var	Function	OUT
0	Dimmer	ALL CH	0	Dimmer	ALL CH	0	Dimmer	ALL CH
1	CCT	ALL CH	1	CCT	ALL CH	1	CCT	ALL CH



MAP: SMART HSV

MAP	FUNCTION		
Smart SHV	Master Dimmer	Master Dimmer (Brightness Value) 0 .. 255	
	Color Correction	Color Temperature Correction 0 ..255	
	Hue	Hue 0 .. 255	
	Hue Rotation (rainbow) Time	Stop 0 .. 25	3s 26 .. 51 6s 52 .. 76 15s 77..102 30s 103..127 1' 128..153 3' 154..179 6' 180..204 15' 205..230 30' 231..254
		Hue Fine 0 .. 15	Hold 16..25
	Saturation	Saturation 0 .. 255	
	Strobo Rate	steady 0..15 blackout 16..31 1fps 32..47 2fps 48..63 3fps 64..79 4fps 80..95 5fps 96..111 6fps 112..127 7fps 128..143 8fps 144..159 9fps 160..175 10fps 176..191 12fps 192..207 14fps 208..223 16fps 224..239 steady 240..254	

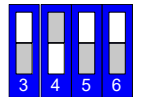
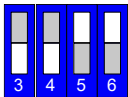

ASSIGNMENT ADDRESSES DEPENDING ON TYPE OF LOAD: RGB and RGBW

Management of single channels (DIP 3 set to "OFF")					
RGB			RGBW		
Var	Function	OUT	Var	Function	OUT
0	DIMMER	CH 1,2,3	0	DIMMER	CH 1,2,3,4
1	CCT	CH 1,2,3	1	CCT	CH 1,2,3,4
2	HUE	CH 1,2,3	2	HUE	CH 1,2,3,4
3	Rainbow	CH 1,2,3	3	Rainbow	CH 1,2,3,4
4	Saturation	CH 1,2,3	4	Saturation	CH 1,2,3,4
5	Strobo	CH 1,2,3	5	Strobo	CH 1,2,3,4
6	DIMMER	CH 4,5,6	6	DIMMER	CH 5,6,7,8
7	CCT	CH 4,5,6	7	CCT	CH 5,6,7,8
8	HUE	CH 4,5,6	8	HUE	CH 5,6,7,8
9	Rainbow	CH 4,5,6	9	Rainbow	CH 5,6,7,8
10	Saturation	CH 4,5,6	10	Saturation	CH 5,6,7,8
11	Strobo	CH 4,5,6	11	Strobo	CH 5,6,7,8
12	DIMMER	CH 7,8,9	12	DIMMER	CH 9,10,11,12
13	CCT	CH 7,8,9	13	CCT	CH 9,10,11,12
14	HUE	CH 7,8,9	14	HUE	CH 9,10,11,12
15	Rainbow	CH 7,8,9	15	Rainbow	CH 9,10,11,12
16	Saturation	CH 7,8,9	16	Saturation	CH 9,10,11,12
17	Strobo	CH 7,8,9	17	Strobo	CH 9,10,11,12
18	DIMMER	CH 10,11,12			
19	CCT	CH 10,11,12			
20	HUE	CH 10,11,12			
21	Rainbow	CH 10,11,12			
22	Saturation	CH 10,11,12			
23	Strobo	CH 10,11,12			

Management of parallel channels (DIP 3 set to "ON")					
RGB			RGBW		
Var	Function	OUT	Var	Function	OUT
0	DIMMER	ALL CH	0	DIMMER	ALL CH
1	CCT	ALL CH	1	CCT	ALL CH
2	HUE	ALL CH	2	HUE	ALL CH
3	Rainbow	ALL CH	3	Rainbow	ALL CH
4	Saturation	ALL CH	4	Saturation	ALL CH
5	Strobo	ALL CH	5	Strobo	ALL CH



MAP: RGB

MAP	Function	
RGB	R	Dimmer R (Brightness Value) 0 .. 255
	G	Dimmer G (Brightness Value) 0 .. 255
	B	Dimmer B (Brightness Value) 0 .. 255

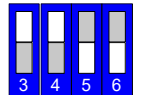
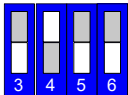

ASSIGNMENT ADDRESSES DEPENDIING ON TYPE OF LOAD: RGB and RGBW

Management of single channels (DIP 3 set to "OFF")					
RGB			RGBW		
Var	Function	OUT	Var	Function	OUT
0	R	CH 1	0	R	CH 1
1	G	CH 2	1	G	CH 2
2	B	CH 3	2	B	CH 3
3	R	CH 4	3	R	CH 5
4	G	CH 5	4	G	CH 6
5	B	CH 6	5	B	CH 7
6	R	CH 7	6	R	CH 9
7	G	CH 8	7	G	CH 10
8	B	CH 9	8	B	CH 11
9	R	CH 10			
10	G	CH 11			
11	B	CH 12			

Management of parallel channels (DIP 3 set to "ON")					
RGB			RGBW		
Var	Function	OUT	Var	Function	OUT
0	R	CH 1,4,7,10	0	R	CH 1,5,9
1	G	CH 2,5,8,11	1	G	CH 2,6,10
2	B	CH 3,6,9,12	2	B	CH 3,7,11



MAP: RGBW

MAP	Function	
RGBW	R	Dimmer R (Brightness Value) 0 .. 255
	G	Dimmer G (Brightness Value) 0 .. 255
	B	Dimmer B (Brightness Value) 0 .. 255
	W	Dimmer W (Brightness Value) 0 .. 255

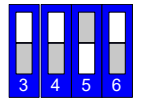
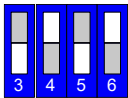

ASSIGNMENT ADDRESSES DEPENDIING ON TYPE OF LOAD: RGB and RGBW

Management of single channels (DIP 3 set to "OFF")					
RGB			RGBW		
Var	Function	OUT	Var	Function	OUT
0	R	CH 1	0	R	CH 1
1	G	CH 2	1	G	CH 2
2	B	CH 3	2	B	CH 3
3	W	CH 1-3	3	W	CH 4
4	R	CH 4	4	R	CH 5
5	G	CH 5	5	G	CH 6
6	B	CH 6	6	B	CH 7
7	W	CH 4-6	7	W	CH 8
8	R	CH 7	8	R	CH 9
9	G	CH 8	9	G	CH 10
10	B	CH 9	10	B	CH 11
11	W	CH 7-9	11	W	CH 12
12	R	CH 10			
13	G	CH 11			
14	B	CH 12			
15	W	CH 10-12			

Management of parallel channels (DIP 3 set to "ON")					
RGB			RGBW		
Var	Function	OUT	Var	Function	OUT
0	R	CH 1,4,7,10	0	R	CH 1,5,9
1	G	CH 2,5,8,11	1	G	CH 2,6,10
2	B	CH 3,6,9,12	2	B	CH 3,7,11
3	W	ALL CH	3	W	CH 4,8,12



MAP: MRGB+

MAP	Function																																
MRGB+	Master Dimmer	Master Dimmer (Brightness Value) 0 .. 255																															
	R	Dimmer R (Brightness Value) 0 .. 255																															
	G	Dimmer G (Brightness Value) 0 .. 255																															
	B	Dimmer B (Brightness Value) 0 .. 255																															
	Strobo Rate	<table border="1" style="font-size: small;"> <tr> <td>steady</td><td>blackout</td><td>1fps</td><td>2fps</td><td>3fps</td><td>4fps</td><td>5fps</td><td>6fps</td><td>7fps</td><td>8fps</td><td>9fps</td><td>10fps</td><td>12fps</td><td>14fps</td><td>16fps</td><td>steady</td> </tr> <tr> <td>0..15</td><td>16..31</td><td>32..47</td><td>48..63</td><td>64..79</td><td>80..95</td><td>96..111</td><td>112..127</td><td>128..143</td><td>144..159</td><td>160..175</td><td>176..191</td><td>192..207</td><td>208..223</td><td>224..239</td><td>240..254</td> </tr> </table>	steady	blackout	1fps	2fps	3fps	4fps	5fps	6fps	7fps	8fps	9fps	10fps	12fps	14fps	16fps	steady	0..15	16..31	32..47	48..63	64..79	80..95	96..111	112..127	128..143	144..159	160..175	176..191	192..207	208..223	224..239
steady	blackout	1fps	2fps	3fps	4fps	5fps	6fps	7fps	8fps	9fps	10fps	12fps	14fps	16fps	steady																		
0..15	16..31	32..47	48..63	64..79	80..95	96..111	112..127	128..143	144..159	160..175	176..191	192..207	208..223	224..239	240..254																		

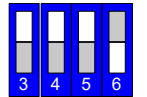
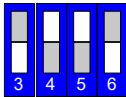

ASSIGNMENT ADDRESSES DEPENDIING ON TYPE OF LOAD: RGB and RGBW

Management of single channels (DIP 3 set to "OFF")					
RGB			RGBW		
Var	Function	OUT	Var	Function	OUT
0	MASTER DIMMER	CH 1-3	0	MASTER DIMMER	CH 1-3
1	R	CH 1	1	R	CH 1
2	G	CH 2	2	G	CH 2
3	B	CH 3	3	B	CH 3
4	STROBO RATE	CH 1-3	4	STROBO RATE	CH 1-3
5	MASTER DIMMER	CH 4-6	5	MASTER DIMMER	CH 5-7
6	R	CH 4	6	R	CH 5
7	G	CH 5	7	G	CH 6
8	B	CH 6	8	B	CH 7
9	STROBO RATE	CH 4-6	9	STROBO RATE	CH 5-7
10	MASTER DIMMER	CH 7-9	10	MASTER DIMMER	CH 9-11
11	R	CH 7	11	R	CH 9
12	G	CH 8	12	G	CH 10
13	B	CH 9	13	B	CH 11
14	STROBO RATE	CH 7-9	14	STROBO RATE	CH 9-11
15	MASTER DIMMER	CH 10-12			
16	R	CH 10			
17	G	CH 11			
18	B	CH 12			
19	STROBO RATE	CH 10-12			

Management of parallel channels (DIP 3 set to "ON")					
RGB			RGBW		
Var	Function	OUT	Var	Function	OUT
0	MASTER DIMMER	ALL CH	0	MASTER DIMMER	CH 1,2,3,5,6,7,9,10,11
1	R	CH 1,4,7,10	1	R	CH 1,5,9
2	G	CH 2,5,8,11	2	G	CH 2,6,10
3	B	CH 3,6,9,12	3	B	CH 3,7,11
4	STROBO RATE	ALL CH	4	STROBO RATE	CH 1,2,3,5,6,7,9,10,11



MAP: MRGBW+

MAP	Function																																
MRGBW+	Master Dimmer	Master Dimmer (Brightness Value) 0 .. 255																															
	R	Dimmer R (Brightness Value) 0 .. 255																															
	G	Dimmer G (Brightness Value) 0 .. 255																															
	B	Dimmer B (Brightness Value) 0 .. 255																															
	W	Dimmer W (Brightness Value) 0 .. 255																															
	Strobo Rate	<table border="1" style="font-size: small;"> <tr> <td>steady</td><td>blackout</td><td>1fps</td><td>2fps</td><td>3fps</td><td>4fps</td><td>5fps</td><td>6fps</td><td>7fps</td><td>8fps</td><td>9fps</td><td>10fps</td><td>12fps</td><td>14fps</td><td>16fps</td><td>steady</td> </tr> <tr> <td>0..15</td><td>16..31</td><td>32..47</td><td>48..63</td><td>64..79</td><td>80..95</td><td>96..111</td><td>112..127</td><td>128..143</td><td>144..159</td><td>160..175</td><td>176..191</td><td>192..207</td><td>208..223</td><td>224..239</td><td>240..254</td> </tr> </table>	steady	blackout	1fps	2fps	3fps	4fps	5fps	6fps	7fps	8fps	9fps	10fps	12fps	14fps	16fps	steady	0..15	16..31	32..47	48..63	64..79	80..95	96..111	112..127	128..143	144..159	160..175	176..191	192..207	208..223	224..239
steady	blackout	1fps	2fps	3fps	4fps	5fps	6fps	7fps	8fps	9fps	10fps	12fps	14fps	16fps	steady																		
0..15	16..31	32..47	48..63	64..79	80..95	96..111	112..127	128..143	144..159	160..175	176..191	192..207	208..223	224..239	240..254																		

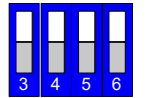
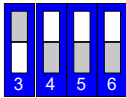

ASSIGNMENT ADDRESSES DEPENDIING ON TYPE OF LOAD: RGB and RGBW

Management of single channels (DIP 3 set to "OFF")					
RGB			RGBW		
Var	Function	OUT	Var	Function	OUT
0	MASTER DIMMER	CH 1-3	0	MASTER DIMMER	CH 1-4
1	R	CH 1	1	R	CH 1
2	G	CH 2	2	G	CH 2
3	B	CH 3	3	B	CH 3
4	W	CH 1-3	4	W	CH 4
5	STROBO RATE	CH 1-3	5	STROBO RATE	CH 1-4
6	MASTER DIMMER	CH 4-6	6	MASTER DIMMER	CH 5-8
7	R	CH 4	7	R	CH 5
8	G	CH 5	8	G	CH 6
9	B	CH 6	9	B	CH 7
10	W	CH 4-6	10	W	CH 8
11	STROBO RATE	CH 4-6	11	STROBO RATE	CH 5-8
12	MASTER DIMMER	CH 7-9	12	MASTER DIMMER	CH 9-12
13	R	CH 7	13	R	CH 9
14	G	CH 8	14	G	CH 10
15	B	CH 9	15	B	CH 11
16	W	CH 7-9	16	W	CH 12
17	STROBO RATE	CH 7-9	17	STROBO RATE	CH 9-12
18	MASTER DIMMER	CH 10-12			
19	R	CH 10			
20	G	CH 11			
21	B	CH 12			
22	W	CH 10-12			
23	STROBO RATE	CH 10-12			

Management of parallel channels (DIP 3 set to "ON")					
RGB			RGBW		
Var	Function	OUT	Var	Function	OUT
0	MASTER DIMMER	ALL CH	0	MASTER DIMMER	ALL CH
1	R	CH 1,4,7,10	1	R	CH 1,5,9
2	G	CH 2,5,8,11	2	G	CH 2,6,10
3	B	CH 3,6,9,12	3	B	CH 3,7,11
4	W	ALL CH	4	W	CH 4,8,9
5	STROBO RATE	ALL CH	5	STROBO RATE	ALL CH

➤ SUPPORTED FUNCTION FOR REDAING AND WRITING – MODBUS RTU

Function code		
0x01	Read Coils	x
0x02	Read Discrete Inputs	x
0x03	Read Holding Registers	✓
0x04	Read Input Register	x
0x05	Write Single Coil	x
0x06	Write Single Register	✓
0x07	Read Exception Status	x
0x08	Diagnostic	x
0x0B	Get Com Event Counter	x
0x0C	Get Com Event Log	x
0x0F	Write Multiple Coils	x
0x10	Write Multiple Registers	✓
0x11	Report Server ID	x
0x14	Read File Record	x
0x15	Write File Record	x
0x16	Mask Write Register	x
0x17	Read/Write Multiple Registers	x
0x18	Read FIFO queue	x
0x2B	Read Device Identification	x